

# V-Series

## V-Series

### CONTURA II, III SWITCHES

The V-Series Contura II & III snap-in rocker switches offer countless unique options including choices for ratings, circuits, colors, illuminations and symbols. These single or double pole switches feature removable actuators in a choice of actuator styles and colors, and can be illuminated with either square or bar shaped lenses. Actuators may be purchased and stocked separately. An optional plug-in terminal connector enables pre-wiring of wire harnesses.

The Contura switches with sealed option, are certified to IP66/68, signifying complete protection against dust and prolonged spray and submersion under pressure, and are recognized to UL1500 - Ignition Protection for Marine Products. These switches are vibration, shock, thermoshock, moisture and salt spray resistant. Temperature ratings range from -40°C to +85°C.



#### Resources:

[Download 3D CAD Files](#)



[Watch Product Video](#)



#### Product Highlights:

- ♦ Countless options for ratings, circuits, colors, illuminations and legends
- ♦ Certified to IP66/68 for front panel components
- ♦ Vibration, shock, thermoshock, moisture and salt spray resistant
- ♦ Temperature range from -40°C to +85°C.

#### Typical Applications:

- ♦ On/Off Highway Equipment
- ♦ Marine
- ♦ Military Armored Vehicles
- ♦ Mining Machinery and Equipment
- ♦ Any application requiring environmental protection



# V-Series Switch

## DESIGN FEATURES

### INTERCHANGEABLE ACTUATORS

Panel redesign is a snap with our wide range of rocker styles. Achieve maximum design variety with minimum inventory. Simply swap rockers to create an entirely new look for your panel.

### DUAL SEAL PROTECTION

Seals out water, dust, debris, and enables switch certification to IP66/68 for front panel components.

### CLEAN CONNECTIONS

Options for both eight and ten terminal base styles with AMP & Packard compatible connectors affords myriad circuit options while providing ease of assembly.



### OPTIONAL PANEL SEAL

Prevents water/dust ingress behind panel.

### MULTIPLE LIGHTING OPTIONS

In addition to Incandescent lamps, our LED illumination is offered in a wide array of light intensities, colors, as well as dual level, tri-color, and flashing options.

### BRASS ROLLER PIN

Robust mechanism eliminates the need for lubricants. Enables switch to withstand -40°C to +85°C temperatures.

### SILVER PLATED BUTT CONTACT MECHANISM

Providing 50k to 100k electrical cycles and a variety of different electrical ratings.

\*Manufacturer reserves the right to change product specification without prior notice.

### Contura II & III

The Contura II & III actuators are constructed of thermoplastic polycarbonate and are offered with a hard nylon overlay or a "soft-touch" elastomer overlay. These models incorporate aesthetic designs on the top and bottom of the rocker featuring two rows of raised "bumps" on the Contura II and three "indented" lines on the Contura III.



### Contura X

The raised bracket/bezel on the Contura X helps prevent inadvertent actuation of the rocker, as well as preventing debris from being trapped under the actuator. This curved rocker style is available with a variety of lenses and legends.



### Contura IV

The Contura IV's "Shape to create a Shape" actuator works with the curves, contours & advanced styling of the latest panel designs, flowing with these advanced curves & radii. This actuator style fits on the Contura flush bracket/bezel.



### Contura XI

The raised bracket/bezel on the Contura XI helps prevent inadvertent actuation of the rocker, as well as preventing debris from being trapped under the actuator. This convex style rocker is available with a wide variety of lenses and legends.



### Contura V

The symmetrically curved Contura V actuator provides the perfect complement to the Contura IV's "Shape to create a Shape" design concept. With its flush style mounting bracket, Contura V can be mounted in between two Contura IV's, by itself, or in groups.



### Contura XII

The Contura XII version features a paddle style actuator with the raised bracket/bezel of Contura X and XI. The contoured handle design provides intuitive recognition and ease of operation and is available with all Contura X and XI lens and legend offerings.



### Contura VI (WAVE)

The Contura VI WAVE sealed rocker switches, when used in a row, create a uniquely appealing "wave" design on your panel. A variety of colors and finishes are available for both rocker and wave insert. Contura VI features bar and oval lenses.



### Contura XIV

The Contura XIV represents a sleek new crossover rocker design which should appeal to Trucks, Buses and Heavy Vehicles as well as the Marine Industry. Intuitive feel is provided by recessed ridges along with a Center Groove which effectively defines the boundary between top and bottom switch functions.



### Contura VII

Contura VII featuring gently curved corners and edges assuring compatibility with most any panel design. Intuitive feel is maximized by the use of 2 embossed circular pads located at opposite ends of the rocker. Any combination of Bar or Oval style lenses can be located in the pads providing a truly unique look, exclusive to Contura VII.



### Illuminated Indicators & Accessories

Alert operator of systems functions or malfunctions, are offered with removable/replaceable lamps in Contura II, II, V or X styles. Accessories include connectors, mounting panels, hole plugs, panel seals, and actuator removal tools. Refer to accessories page for full details



### Electrical

Contact Rating	.4VA @ 24VDC (MAX) resistive 15 amps, 125VAC 10 amps, 250VAC 1/2 HP 125-250VAC 20 amps, 4-14VDC 15 amps, 15-28VDC 10A, 14VT 6A, 125VAC L
Dielectric Strength	1500 Volts RMS
Insulation Resistance	50 Megohms
Initial Contact Resistance	10 milliohms max. @ 4VDC
Life	50,000 - 100,000 cycles circuit dependent
Contacts	Silver alloy, silver tin-oxide, fine silver
Terminals	Brass or copper/silver plate 1/4" (6.3mm) Quick Connect terminations standard. Solder lug, Wire Lead

### Mechanical

Endurance	150,000 cycles minimum circuit dependent
-----------	--

### Physical

Lighted	Incandescent - rated 10,000 hours Neon - rated 25,000 hours LED - rated 100,000 hours 1/2 life (LED is internally ballasted for voltages to 24VDC)
Seals	Internal
Base	Optional external gasket panel seal Polyester blend rated to 125°C with a UL flammability rating of 94V0.
Contura II,III,IV,V, VI, VII Actuator	<b>Hard Surface:</b> Basic actuator structure molded of thermoplastic polycarbonate with a hard Nylon 66 thermoplastic surface overlay. <b>Soft Surface:</b> Basic actuator structure molded of thermoplastic polycarbonate with an elastomer overlay.
Contura X,XI,XII Actuator,VP	Nylon 66 Reinforced rated to 105°C
Lens	Polycarbonate rated at 100°C
Contura XIV	Polycarbonate lens/sub-rocker with ABS shell

### Actuator Travel (Angular Displacement)

2 position	18°
3 positions	9° from center

### Mounting Specifications

Panel Thickness Range

<b>Gaskets Acceptable Panel Thickness</b>	
0	.030 to .250 (.76 to 6.35mm)
1	.030 to .109 & .147 to .157 (.76 to 2.77mm & 3.73 to 3.98mm)

Recommended: No gasket with panel thickness of .032, .062, .093, .125, .187 or .250



### Agency Certifications



### Environmental

Sealing	Sealed version: IP66/68, this rating applies to front panel components of the actual switch only, and signifies complete protection against dust as well as powerful jets of water.
Corrosion	Mixed Flowing Gas (MFG) Class III 3 year accelerated exposure per ASTM B-827, B-845 Silver and gold contacts
Operating Temp.	-40°C to +85°C
Vibration 1	Per Mil-Std 202F, Method 204D Test Condition A 0.06 DA or 10G's 10-500 Hz. Tested with VCH connector. Test criteria - No loss of circuit during test, pre and post test contact resistance.
Vibration 2	Resonance search 24-50 Hz 0.40 DA 50-2000 Hz ±10 G's peak Horizontal Axis 3-5 G's max. Random 24 Hz 0.06 PSD-Gsq/Hz 60 Hz 0.50 100 Hz 0.50 200 Hz 0.025 2000 Hz 0.025 No loss of circuit during test; <10µ seconds chatter.
Shock	Per Mil-Std 202F, Method 213B, Test Condition K @ 30G's. Tested with VCH connector. Test criteria - No loss of circuit during test, pre and post test contact resistance.
Salt Spray	Per Mil-Std 202F, Method 101D, Test Condition A, 96 Hrs. Sealed version only.
Dust	Mil STD 810, Method 510.2 Air Velocity 300 Ft/Min Duration 16Hr
Thermal Shock	Per Mil-Std 202F, Method 107F, Test Cond. A, -55°C to +85°C. Test criteria - pre and post test contact resistance
Moisture Resistance	Per Mil-Std 202F, Method 106F, Test Criteria - pre and post test contact resistance
Ignition Protection	All Contura switches with sealed construction meet the requirements of UL1500/ISO8846 for ignition protection, in addition to conformance with EC directive 94/25/EC for marine products.

**V 1 D A B T O B - A R B 00 - 0 00**

1 Series 2 Circuit 3 Rating 4 Termination Illumination 5 Lamp 6 Lamp 7 Lamp 8 Bracket 9 Actuator 10 Lens 11 Color 12 Legend 13 Legend Orientation 14 Actuator Lens Legend

**1 SERIES**  
V

**2 CIRCUIT**

Terminal Connections as viewed ( ) - momentary from bottom of switch: SP - single pole - uses terminals 1, 2 & 3. DP - double pole uses terminals 1, 2, 3, 4, 5 & 6.  
**8 terminal 10 terminal** Terminals 7, 8, 9 & 10 for lamp circuit only.  
 8 - -7 8 - -7  
 1 - -4 1 - -4  
 2 - -5 2 - -5  
 3 - -6 3 - -6  
 10 - -9

Position:	1	2	3
SP DP	2 & 3, 5 & 6	Connected Terminals	1 & 2, 4 & 5
1 A	ON	NONE	OFF
2 B	(ON)	NONE	OFF
3 C	ON	NONE	(OFF)
4 D	ON	NONE	ON
5 F	ON	NONE	(ON)
6 J	ON	OFF	ON
7 K	ON	OFF	(ON)
8 L	(ON)	OFF	(ON)

**SPECIAL CIRCUITS**

H*	2 & 3	2 & 3, 5 & 4	5 & 4
G*	2 & 3, 5 & 6	2 & 3	OFF
S*	2 & 3, 5 & 6	2 & 3	1 & 2
M*	(2 & 3, 5 & 6)	2 & 3	OFF
R*	(2 & 3, 5 & 6)	2 & 3	2 & 1
E*	5 & 6	5 & 3	5 & 1

\*Jumper between terminals 2 & 5 for circuits H, G, M, R & S are provided in selection 4. External jumper between terminals 2 & 4 for circuit E are provided by customer. Circuit E may be used for SP OFF-ON-ON circuit.

**3 RATING 3**

1	.4VA @ 28VDC Resistive
B	15A 24V
C	20A 18V
D	20A 12V
E	20A 14V, 10A 14V (circuit 1, 4, A & D only)
F	10A 14V, 6A 14V (circuit G only)
M	.4VA/20A 12V
N	.4VA/15A 24V

**4 TERMINATION / BASE STYLE**

8 term	10 Term	Termination	Jumper
1	2	.250 TAB (QC) no barriers	No
A	B	.250 TAB (QC) with barriers	No
J	K	.250 TAB (QC) no barriers	Yes T2 to 5
3	5	Solder Lug no barriers	No
C	D	Solder Lug	No
5	6	Wire Leads no barriers	No
E	F	Wire Leads	No

Note: Codes J & K for circuits H, G & M. Do not use silicone based lubricants to reduce terminal insertion forces during connector assembly, as it is detrimental to function and performance.

**5 ILLUMINATION**

Lamp #1: above terminals 1 & 4 end of switch.; Lamp #2 above terminals 3 & 6 end of switch. Positive (+) and negative (-) symbols apply to LED lamps only

Sealed	Unsealed	Lamps	Illumination Type	Lamp wired to Terminals
S	0	NONE	-	-
A	1	1	INDEPENDENT	8 (+) 7 (-)
B	2	1	DOWN	3 (+) 7 (-)
C	3	2	UP	3 (+) 7 (-)
D	4	1	DOWN	3 (+) 7 (-)
E	5	2	DOWN	1 (+) 7 (-)
F	6	1	UP	1 (+) 7 (-)
G	7	2	UP	3 (+) 7 (-)
H	Z	2	INDEPENDENT	8 (+) 7 (-)
U	Y	1	INDEPENDENT	8 (+) 7 (-)
		2	INDEPENDENT	10 (+) 9 (-)
<b>SINGLE POLE SWITCHES ONLY</b>				
J	8	1	DOWN	3 (+) 8 (-)
K	W	2	INDEPENDENT	6 (+) 7 (-)
		1	INDEPENDENT	8 (+) 7 (-)
		2	INDEPENDENT	6 (+) 7 (-)
<b>DOUBLE POLE SWITCHES ONLY</b>				
L	9	1	DOWN	3 (+) 6 (-)
M	R	1	UP	3 (+) 6 (-)
N	T	1	DOWN	3 (+) 6 (-)
		2	DOWN	1 (+) 4 (-)
P	V	1	UP	1 (+) 4 (-)
		2	UP	3 (+) 6 (-)

**6,7 LAMP (SAME CODING FOR BOTH SELECTIONS)**

Selection 6: above terminals 1 & 4; Selection 7: above terminals 3 & 6  
 No lamp 0  
 Neon 1 125VAC 2 250VAC  
 Incandescent 4 3V 5 6V  
 LED\* 6 12V superbright Green 7 18V superbright Red 8 24V  
 2VDC Red A Amber L F G  
 6VDC Amber B L M N P  
 12VDC C D  
 24VDC  
 \* Consult factory for "daylight bright" LED options. Typical current draw for LED is 20ma.

**8 FLUSH BRACKET COLOR 1, PANEL SEAL**

No Seal	Black B	White W	Gray G
One Seal	C	Y	H

**9 ACTUATOR**

0 No Actuator  
 A, B Contura II  
 C, D Contura III

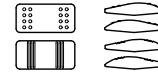

Actuator orientation above terminals: 3.6 1.4

**10 LENS**

0 - No Actuator	Z - No Lens
Clear White 1 6	Amber 8 G
2 7 C	Green 9 H
3 8 D	Red 10 J
4 9 E	Blue 11 K
5 A F	12 L S
	13 M T
	14 N U
	15 P V
	16 R W
	17 S Y

Lens color for LEDs must be clear, white, or match color of LED. Green or blue lenses are not recommended with Neon lamps.

**11 ACTUATOR COLOR 1 AND TEXTURE**

0 - No Actuator	Black B	Gray G	Red R	White W
Soft Surface	C	H	S	Y
Hard Surface				

**12 ACTUATOR LENS OR BODY LEGENDS 2**

11 ON	12 OFF	13 I	14 O
OFF	ON	O	I
15 O O	16 O O	17 O I	18 I O
F N	N F		
F	F		

For additional legend options & codes, visit us at [www.carlingtech.com](http://www.carlingtech.com).

**13 LEGEND ORIENTATION**

0 No legend (used with codes 11-18 in selection 12)

1 Orientation 1  
 2 Orientation 2  
 3 Orientation 3  
 4 Orientation 4

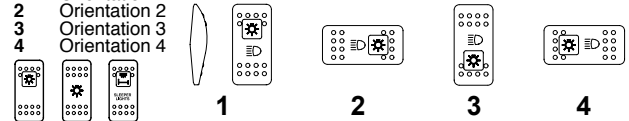

**14 ACTUATOR LENS LEGEND**

00 No legend this location / no actuator (used with codes 11-18 in selection 12) Selection 14 required when switch requires two legends. If the two legends consist of one lens and one body legend, lens legend must be specified in selection 12; body legend specified in selection 14. For legend options & codes, visit us at [www.carlingtech.com](http://www.carlingtech.com).

**Notes:**

Consult factory to verify horsepower rating for your particular circuit choice.

- 1 Custom colors are available. Consult factory.
- 2 Body legends not available on Soft surface actuators; White imprinting is standard on black actuators; Black imprinting is standard on white, red and gray actuators. Custom colors are available, consult factory.
- 3 Additional ratings available. See V-Series Switch Accessories page.
- 4 Contura II available with two square lenses. Consult factory for details.



**V 1 D A S W O B - A Z E 00 - 0**

1 Series    2 Circuit    3 Rating    4 Termination Illumination Lock    5 Lamp    6 Bracket    7 Actuator    8 Lens    9 Function    10 Legend    11 Legend Orientation

**1 SERIES**  
V

**2 CIRCUIT**

Terminal Connections as viewed ( ) - momentary from bottom of switch: SP - single pole - uses terminals 1, 2 & 3. DP - double pole uses terminals 1, 2, 3, 4, 5 & 6. **8 terminal 10 terminal** Terminals 7, 8, 9 & 10 for lamp circuit only.

8 - -7	8 - -7	Terminals 7, 8, 9 & 10 for lamp circuit only.	
1 - -4	1 - -4		
2 - -5	2 - -5		
3 - -6	3 - -6		
	10 - -9		
<b>Position:</b>		<b>1</b>	<b>2</b>
SP DP		2 & 3, 5 & 6	Connected Terminals 1 & 2, 4 & 5
1 A		ON	NONE OFF
4 D		ON	NONE ON
6 J		ON	OFF ON
7 K		ON	OFF (ON)
8 L		(ON)	OFF (ON)
9 N		OFF	NONE ON

**SPECIAL CIRCUITS**

H*		2 & 3	2 & 3, 5 & 4	5 & 4
G*		2 & 3, 5 & 6	2 & 3	OFF
S*		2 & 3, 5 & 6	2 & 3	1 & 2
M*		(2 & 3, 5 & 6)	2 & 3	OFF
R*		(2 & 3, 5 & 6)	2 & 3	2 & 1
E*		5 & 6	5 & 3	5 & 1

\*Jumper between terminals 2 & 5 for circuits H,G,M,R & S are specified in selection 4. External jumper between terminals 2 & 4 for circuit E are provided by customer. Circuit E may be used for SP OFF-ON-ON circuit.

**3 RATING 4**

- 1 .4VA @ 28VDC Resistive
- B 15A 24V
- C 20A 18V
- D 20A 12V
- E 20A 14V, 10A 14VT (circuit 1, 4, A & D only)
- F 10A 14V, 6A 14VT (circuit G only)
- M 4VA/20A 12V
- N .4VA/15A 24V

**4 TERMINATION / BASE STYLE**

8 term	10 Term	Termination	Jumper
1	2	.250 TAB (QC) no barriers	No
A	B	.250 TAB (QC) with barriers	No
J	K	.250 TAB (QC) no barriers	Yes T2 to 5
3	5	Solder Lug no barriers	No
C	D	Solder Lug	No
E	F	Wire Leads no barriers	No
		Wire Leads	No

Note: Codes J & K for circuits H, G & M. Do not use silicone based lubricants to reduce terminal insertion forces during connector assembly, as it is detrimental to function and performance.

**5 ILLUMINATION & SWITCH SEALING**

Lamp #1: above terminals 1 & 4 end of switch.; Lamp #2 above terminals 3 & 6 end of switch. Positive (+) and negative (-) symbols apply to LED lamps only

Sealed	Unsealed	Lamps	Illumination Type	Lamp wired to Terminals
S	0	NONE	-	-
C	3		UP	3 (+) 7 (-)
H	Z		INDEPENDENT	8 (+) 7 (-)
<b>DOUBLE POLE SWITCHES ONLY</b>				
M	R	1	UP	3 (+) 6 (-)

**6 LOCK**

Lock above terminals 1 & 4 end of switch  
W lock

**7 LAMP**

Lamp above terminals 3 & 6 end of switch

No lamp	0				
Neon	1	125VAC	2	250VAC	
Incandescent	4	3V	5	6V	
LED*			6	12V	7
				superbright Green	18V superbright Red
2VDC	A	Red	L	Amber	F
6VDC	B		M		G
12VDC	C		N		H
24VDC	D		P		J

\* Consult factory for "daylight bright" LED options. Typical current draw for LED is 20ma.

**8 FLUSH BRACKET COLOR 1, PANEL SEAL**

	Black	White	Gray
No Seal	B	W	G
One Seal	C	Y	H

**9 HARD SURFACE ACTUATOR 1**

	Black	Gray	Red	White
Contura II	A	B	G	H
Contura III	C	D	E	F

Actuator orientation above terminals:  
3.6 1.4

**10 LENS**

Z - No Lens

	Amber	Green	Red	Blue
3	8	D	J	P
				V

Lens color for LEDs must be clear, white, or match color of LED. Green or blue lenses are not recommended with Neon lamps.

**11 ACTUATOR LOCK FUNCTION AND COLOR 1**

Lock Color	Up	Down	Up & Down	Center 3
Match Actuator	A	H	R	1
Black	B	J	S	2
White	C	K	T	3
Red	D	L	V	4
Safety Orange	E	M	W	5

**12 ACTUATOR LENS OR BODY LEGEND 2**

00 - No Legend

21	22	23	24
OFF	ON	O	I
25	O	26	O
	F	N	

For additional legend options & codes, visit us at [www.carlingtech.com](http://www.carlingtech.com).

**13 LEGEND ORIENTATION**

0 No legend (used with codes 21-28 in selection 12)

1	Orientation 1
2	Orientation 2
3	Orientation 3
4	Orientation 4

1 2 3 4

Notes:

- Consult factory to verify horsepower rating for your particular circuit choice.
- 1 Custom colors are available. Consult factory.
- 2 White imprinting is standard on black actuators; Black imprinting is standard on white, red and gray actuators. Custom colors are available, consult factory.
- 3 Only available with 3 position circuits. Center OFF and special circuits only available with center position lock function.
- 4 Additional ratings available. See V-Series Switch Accessories page.

**Dimensional Specifications: in. [mm]**

**CONTURA II**

SHOWN WITH SQUARE LENS

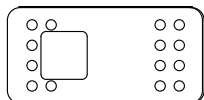

**CONTURA III**

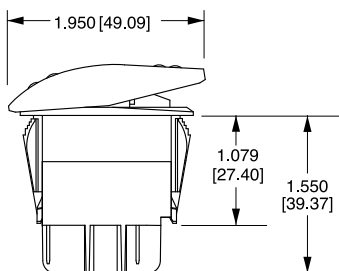
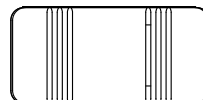

**8 TERMINAL BASE W/BARRIERS**

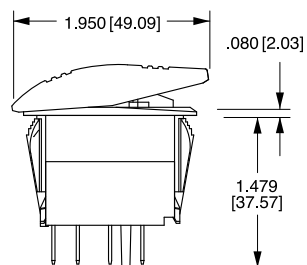

**8 TERMINAL BASE W/O BARRIERS**

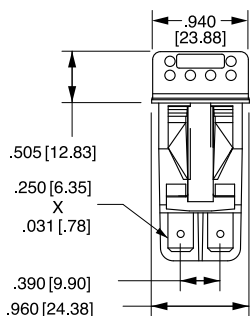

**8 TERMINAL BASE W/BARRIERS**

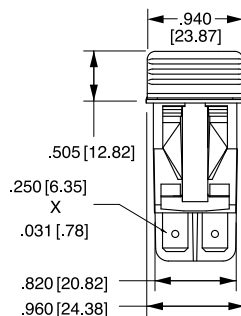

**10 TERMINAL BASE W/BARRIERS**

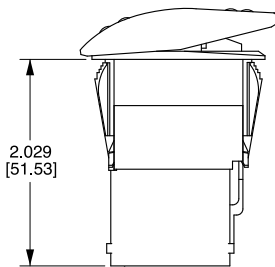

**SWITCH SHOWN WITH VCH CONNECTOR 8 TERMINAL**

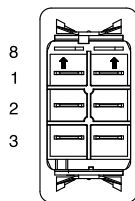

**BOTTOM VIEW TERMINAL ARRANGEMENT 8 TERMINAL BASE**

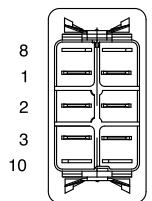

**BOTTOM VIEW TERMINAL ARRANGEMENT 10 TERMINAL BASE**

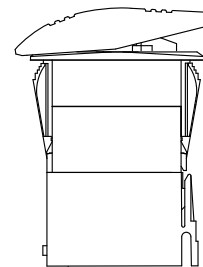

**SWITCH SHOWN WITH VC1 CONNECTOR 10 TERMINAL**

**Circuit Diagrams:**

CIRCUIT CODE	CIRCUIT DIAGRAM
1	
2	
3	
4	
5	
6	
7	
8	

CIRCUIT CODE	CIRCUIT DIAGRAM
A	
B	
C	
D	
E	
F	
G	
H	

CIRCUIT CODE	CIRCUIT DIAGRAM
J	
K	
L	
M	
R	
S	

SYMBOL LEGEND	
SYM.	DEFINITION
	DESIGNATES TERMINALS AND CONTACTS
	DESIGNATES MAINTAINED CIRCUITS
	DESIGNATES OTHER POSITION
	DESIGNATES MOMENTARY CIRCUITS
	DESIGNATES TWO POSITION CONNECTION
	DESIGNATES EXTERNAL JUMPER PROVIDED BY CUSTOMER



### Lamp Circuit Diagrams:

LAMP CIRCUIT CODE	CIRCUIT DIAGRAM	LAMP CIRCUIT CODE	CIRCUIT DIAGRAM	LAMP CIRCUIT CODE	CIRCUIT DIAGRAM	LAMP CIRCUIT CODE	CIRCUIT DIAGRAM
A / 1		F / 6		L / 9		SPECIAL #1	
B / 2		G / 7		M / R		SPECIAL #3	
C / 3		H / Z		N / T		SPECIAL #4	
D / 4		J / 8		P / V			
E / 5		K / W		U / Y			

### J-Series Hazard Warning Circuit Diagrams:

CIRCUIT CODE	CIRCUIT DIAGRAM	CIRCUIT CODE	CIRCUIT DIAGRAM
J1		J5	
J2		JA	
J3		JJ	
J4		JK	

NOTE:  
J circuits are available for all non-locking V-Series styles.  
Consult factory for partnumber details.

SYMBOL LEGEND	
SYM.	DEFINITION
○	DESIGNATES TERMINALS AND CONTACTS
○	DESIGNATES LAMP LOCATION

**Reduce inventory levels and cost by stocking actuators and base switches separately.**

**Contura II, III, IV, V, VI, VII, X, XI, XII, XIV Base switches separately:** specify **V** with code selections 2-8 in the ordering schemes.

**Contura II, III, IV, V Actuator only:** **VV** with code **A** or **C** for selection 9, & with selections 10-14 in the ordering schemes.

**Contura VI Actuator with lenses and inserts only:** **VV** with code selections 9-16

**Contura II, III, IV, V, VII Actuator only:** **VV** with code **A, C, E, G, P** or **Z** for selection 9 & with selections 10-14 in the ordering schemes.

**Contura X, XI, XII, XIV actuators with lenses separately:** **VV** with code selections 9-14 in the ordering schemes.

**Panel Seal:** VPS

**Contura X & XI actuators without lenses separately:**

**VVR 6 1 00 1**

1 Actuator Separately 2 Actuator Style/Color 3 Lens Opening 4 Actuator Legend 5 Legend Orientation

**1 CONTURA X & XI ACTUATOR SEPARATELY**  
**VVR**

**2 ACTUATOR STYLE & COLOR**

	Black	Gray	White	Red
Contura X	1	2	3	4
Contura XI	6	7	8	9

**3 LENS OPENING FOR 1**

1 One bar lens 5 square lens on top/  
2 One bar lenses bar lens on bottom  
3 One square lens (Contura X only)  
4 two square lens

**4 ACTUATOR LENS OR BODY LEGEND**

00 - No Legend this location  
11 ON 12 OFF 13 I 14 O  
OFF ON O I  
15 O O 16 O O 17 O I 18 I O  
F N N F F F  
For additional legend options & codes, visit us at [www.carlingtech.com](http://www.carlingtech.com).

**5 LEGEND ORIENTATION 1**

0 No legend 1 Orientation 1 2 Orientation 2 3 Orientation 3 4 Orientation 4

**Contura XII actuators without lenses separately:**

**VVP J 1 Z 21 1 00**

1 Actuator 2 Style & Color 3 Lens Opening 4 Lens Opening 5 Legend 6 Legend Orientation 7 Legend Orientation

**1 CONTURA XII ACTUATOR SEPARATELY**  
**VVP**

**2 ACTUATOR STYLE & COLOR**

J Black K Gray N White M Red

**3,4 LENS OPENING FOR**

Z No lens 1 Bar lens 2 Square lens

**5, 7 LENS OR BODY LEGEND 2**

00 - No Legend 21 OFF 22 ON 23 O 24 I  
25 O 26 O 27 O 28 I  
F N F N  
For additional legend options & codes, visit us at [www.carlingtech.com](http://www.carlingtech.com).

**6 LEGEND ORIENTATION 3**

0 No legend 1 Orientation 1 2 Orientation 2

**Contura X, XI & XII actuator lens assembly separately:**

**VVL 2 1 00 0**

1 Lens Separately 2 Lens Style 3 Lens Color 4 Legend 5 Legend Orientation

**1 CONTURA X, XI & XII LENS SEPARATELY**  
**VVL**

**2 LENS STYLE 3**

1 Bar lens 2 One Piece Square lens 3 Bottom of Two-Piece Square lens 5

**3 TRANSLUCENT LENS COLOR**

1 Clear 2 White 3 Amber 4 Green 4 5 Red 6 Blue 4

**4 LENS OR BODY LEGEND 2**

00 - No Legend 21 OFF 22 ON 23 O 24 I  
25 O 26 O 27 O 28 I  
F N F N  
For additional legend options & codes, visit us at [www.carlingtech.com](http://www.carlingtech.com).

**5 LEGEND ORIENTATION 3**

0 No legend 1 Orientation 1 2 Orientation 2 3 Orientation 3 4 Orientation 4

**Contura X, XI & XII top piece of 2-piece lens separately:**

**VVT 1**

1 Lens Separately 2 Color

**1 TOP OF LENS SEPARATELY**  
**VVT**

**2 COLOR**  
1 Clear 2 Smoke 3 White

**Contura X, XI & XII actuator lens assembly:**



1 piece lens/bar lens are positioned the same as bottom lens for assembly, minus the top lens. Lenses snap in from bottom.

**Notes:**

- If actuator lens opening for 2 bar or 2 square lenses, legend orientation 0,1, or 2 must be chosen.
- Center of actuator marking not available for Contura XII.
- Legend is not available for bar style lens.
- Not recommended with neon lamps.
- Must also order top piece of 2 piece square lens separately.

## Easily integrate Contura products into your system, with Contura Accessories

### Contura Connectors

Q.C. SELECTION GUIDE					
COMPANY SERIES	PART NO		WIRE RANGE		ORIENTATION
	PLAIN BRASS	TIN PLATED BRASS	AWG	MM <sup>2</sup> (REF)	
PACKARD 58 SERIES	02965580		12	3.0	B
	02965471	12010601	(2)16-14	(2)1.0-2.0	
	02965470		16-14	1.0-2.0	
	02965469	06288318	20-18	.5-.8	
PACKARD METRI-PACK 630 SERIES		12084590	10	5.0	A
		12052224	12	3.0	
		12015870	16-14	1.0-2.0	
		12020035	(2)22-18	(2).5-.8	
		12015832	20-18	.5-.8	
		12052222	20-22	.35-.5	
AMP 250 SERIES FASTIN-FASTON	60253-1	60253-2	16-12	1.3-3	B
	42100-1	42100-2	(2) 16	(2) 1.3	
	60295-1	60295-2	18-14	.8-2	
			22-18	.3-.9	



**NOTE:** Consult Delphi Packard and/or Amp on actual part numbers and availability. AMP is a registered trademark of AMP Inc. Harrisburg, PA. Delphi Packard is a registered trademark of Delphi-Packard Electrical Systems Warren, Ohio.



### Contura X Boot (P/N VB1-01)

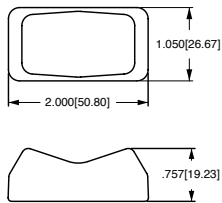

### Contura II, III, IV, V, VI & VII Actuator Removal Tool (P/N VRT)

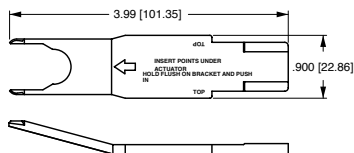

### Additional V-Series Ratings

- 1 .4VA @ 28VDC Resistive
- 4 10A 250VAC 1/2 HP, 15A 125 VAC 1/2 HP, No Agency Listings
- 5<sup>1</sup> 10A 250VAC 1/2 HP, 15A 125 VAC 1/2 HP, UL Recognized, CSA Certified
- B 15A 24V
- C 20A 18V
- D 20A 12V
- E 20A 14V, 10A 14VT (circuits 1, 4, A, & D only)
- F 10A 14V, 6A, 14VT (circuit G only)
- G 20A 6V
- H 20A 3V
- L<sup>2</sup> 15A 125 VAC, 10A 250VAC, 1/2 HP 125-250 VAC; 6A 125 VAC L
- M .4VA/20A 12V (combi-contact)  
(combination gold/silver contacts for borderline dry circuit applications)
- N .4VA/15A 24V (combi-contact)  
(combination gold/silver contacts for borderline dry circuit applications)

**NOTES**

- Consult factory to determine availability for individual circuits and their HP rating.
1. Not available with Contura 7 or 14 rocker styles.
  2. Rating L available with circuits 1, 4, A & D only.

## Contura Mounting Panels Dimensional Specifications: in. [mm]

**MOUNTING PANEL**  
For additional units, add 1.03[26.2] per unit.  
For more than 2 V-Series Switches, add  
middle section. Available in Panel Thicknesses  
listed below. Consult factory.

**MOUNTING PANEL THICKNESS**  
.062[1.57] .187[4.75]  
.093[2.36] .250[6.35]  
.125[3.17] .375[9.52]



## Contura Hole Plug Dimensional Specifications: in. [mm]

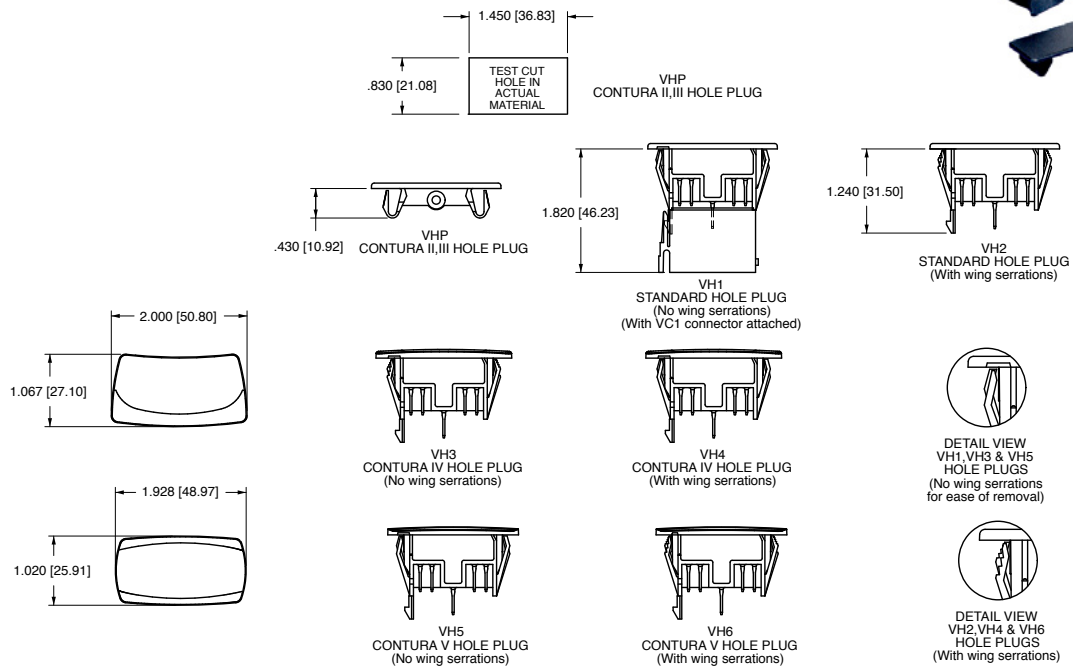

## Authorized Sales Representatives and Distributors

Click on a region of the map below to find your local representatives and distributors or visit [www.carlingtech.com/findarep](http://www.carlingtech.com/findarep).



## About Carling

Founded in 1920, Carling Technologies is a leading manufacturer of electrical and electronic switches and assemblies, circuit breakers, electronic controls, power distribution units, and multiplexed power distribution systems. With four ISO registered manufacturing facilities and technical sales offices worldwide, Carling Technologies Sales, Service and Engineering teams do much more than manufacture electrical components, they engineer powerful solutions! To learn more about Carling please visit [www.carlingtech.com/company-profile](http://www.carlingtech.com/company-profile).

To view all of Carling's environmental, quality, health & safety certifications please visit [www.carlingtech.com/environmental-certifications](http://www.carlingtech.com/environmental-certifications)

## **Worldwide Headquarters**

Carling Technologies, Inc.  
60 Johnson Avenue, Plainville, CT 06062  
**Phone:** 860.793.9281 **Fax:** 860.793.9231  
**Email:** sales@carlingtech.com

**Northern Region Sales Office:** nrsm@carlingtech.com  
**Southeast Region Sales Office:** sersm@carlingtech.com  
**Midwest Region Sales Office:** mrsrm@carlingtech.com  
**West Region Sales Office:** wrsm@carlingtech.com  
**Latin America Sales Office:** larsm@carlingtech.com

## **Asia-Pacific Headquarters**

Carling Technologies, Asia-Pacific Ltd.,  
Suite 1607, 16/F Tower 2, The Gateway,  
Harbour City, 25 Canton Road,  
Tsimshatsui, Kowloon, Hong Kong  
**Phone:** Int + 852-2737-2277 **Fax:** Int + 852-2736-9332  
**Email:** sales@carlingtech.com.hk

**Shenzhen, China:** shenzhen@carlingtech.com  
**Shanghai, China:** shanghai@carlingtech.com  
**Pune, India:** india@carlingtech.com  
**Kaohsiung, Taiwan:** taiwan@carlingtech.com  
**Yokohama, Japan:** japan@carlingtech.com

## **Europe | Middle East | Africa Headquarters**

Carling Technologies LTD  
4 Airport Business Park, Exeter Airport,  
Clyst Honiton, Exeter, Devon, EX5 2UL, UK  
**Phone:** Int + 44 1392.364422 **Fax:** Int + 44 1392.364477  
**Email:** ltd.sales@carlingtech.com

**Germany:** gmbh@carlingtech.com  
**France:** sas@carlingtech.com



**Carling Technologies®**

Innovative Designs. Powerful Solutions.